

Mechanical Drawings POS-Line 46.0" (1168.4 mm)

Revision 4.0
09 | 2024

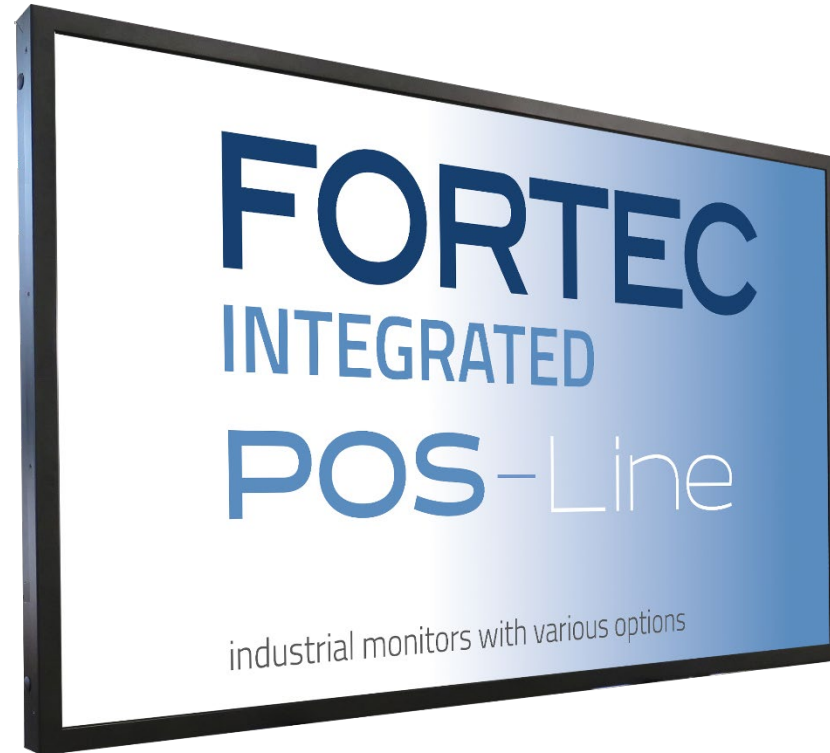

Copying of this document and giving to others and the use or communication of the contents thereof are forbidden without express authority. Offenders are liable to the payment of damages. All rights are reserved in the event of the grant of a patent or registration of utility model or design.

Die Weitergabe sowie Vervielfältigung dieser Unterlagen und Mitteilung ihres Inhalts ist nicht gestattet, soweit nicht ausdrücklich zugestanden. Zuwiderhandlungen verpflichten zu Schadensersatz. Alle Rechte für den Fall der Patentverteilung oder GM-Eintragung vorbehalten.

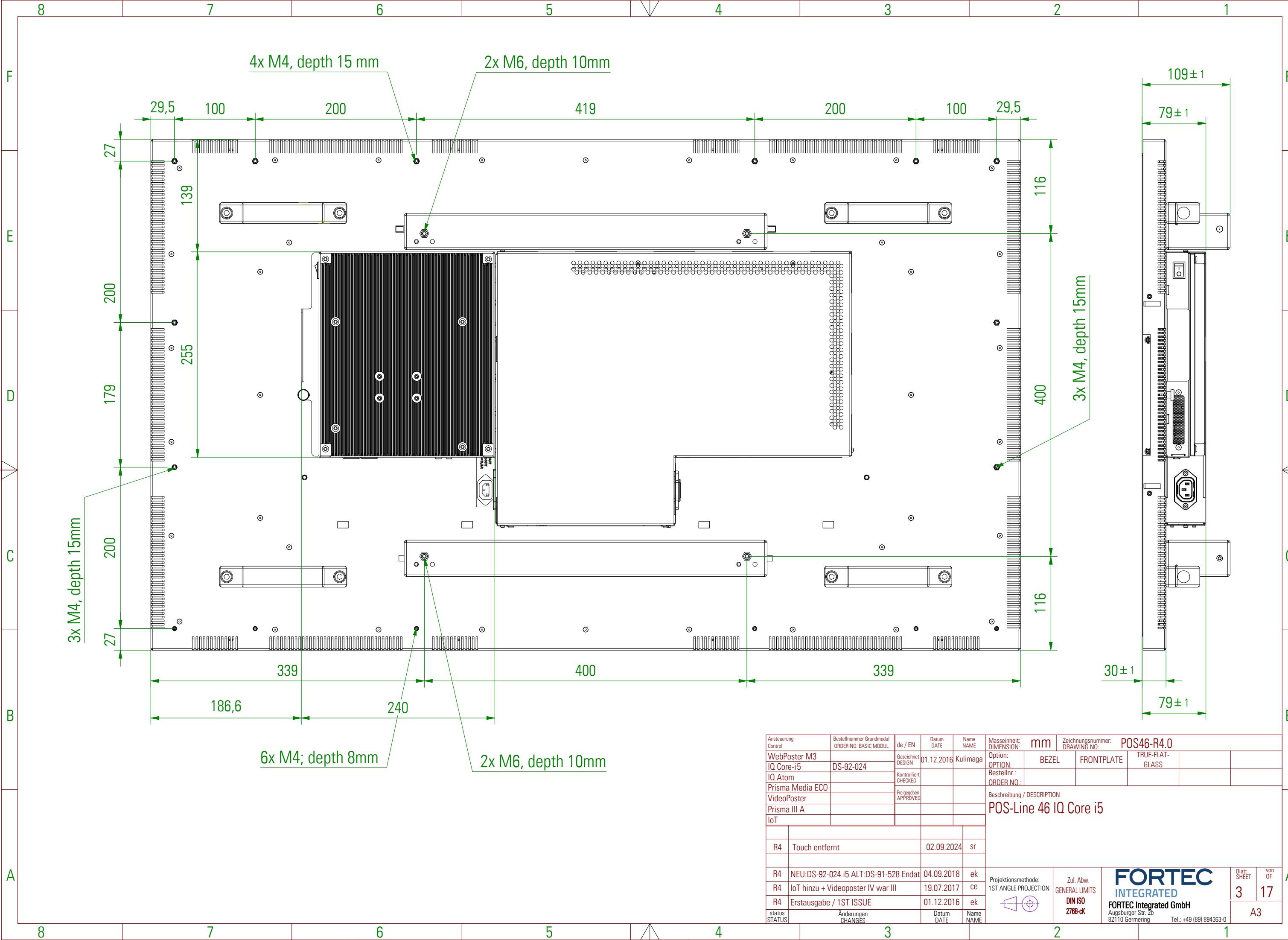

Ansteuerung Control	Bestellnummer Grundmodul ORDER NO. BASIC MODUL	de / EN	Datum DATE	Name NAME	Masseinheit: DIMENSION:	mm	Zeichnungsnummer: DRAWING NO.:	POS46-R4.0		
WebPoster M3	IQ Core-i5	Gezeichnet DESIGN	01.12.2016	Kulmaga	Option:	BEZEL	FRONTPLATE	TRUE-FLAT-GLASS		
IQ Atom	DS-92-024	Kontrolliert CHECKED			Bestellnr.:					
Prisma Media ECO		Freigegeben APPROVED			ORDER NO.:					
VideoPoster					Beschreibung / DESCRIPTION					
Prisma III A					POS-Line 46 IQ Core i5					
IoT										
R4	Touch entfernt		02.09.2024	sr						
R4	NEU:DS-92-024 i5 ALT:DS-91-528 Endat		04.09.2018	ek						
R4	IoT hinzu + Videoposter IV war III		19.07.2017	ce	Projektionsmethode: 1ST ANGLE PROJECTION	Zul. Abw. GENERAL LIMITS DIN ISO 2768-cK	FORTEC INTEGRATED FORTEC Integrated GmbH Augsburg Str. 2b 82110 Germering Tel.: +49 (89) 894363-0		Blatt SHEET	von OF
R4	Erstausgabe / 1ST ISSUE		01.12.2016	ek					3	17
status STATUS	Änderungen CHANGES		Datum DATE	Name NAME					A3	

IQ Atom

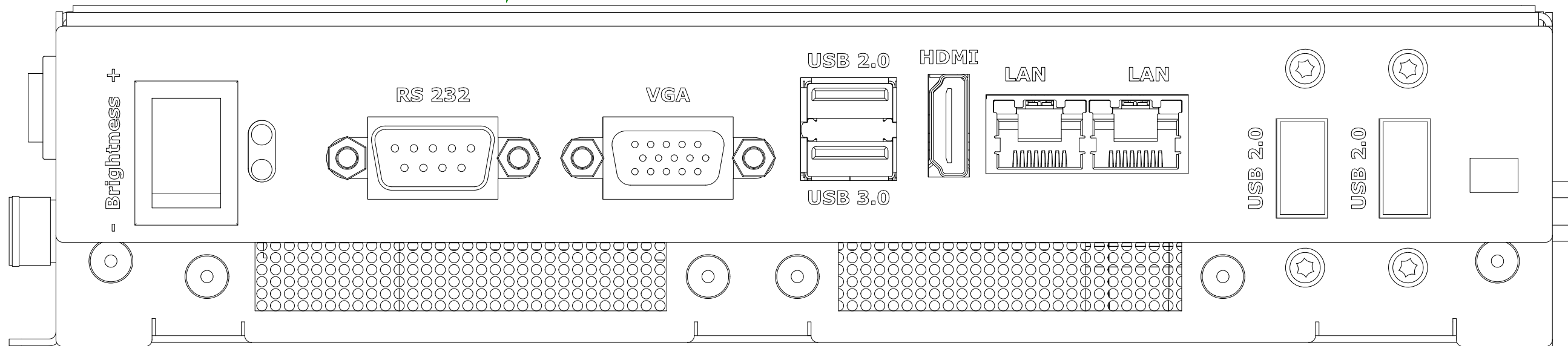
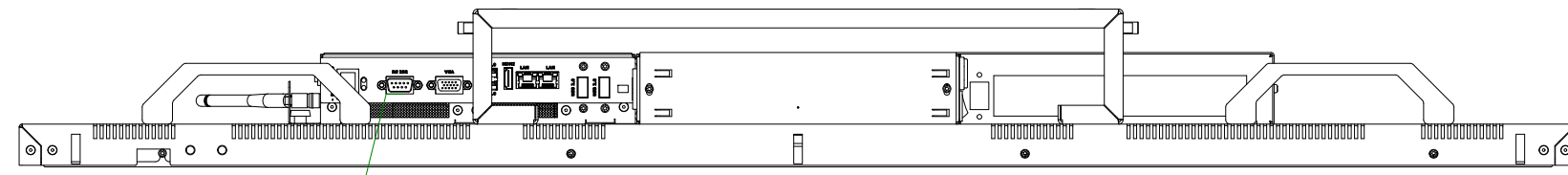

IQ Core i5

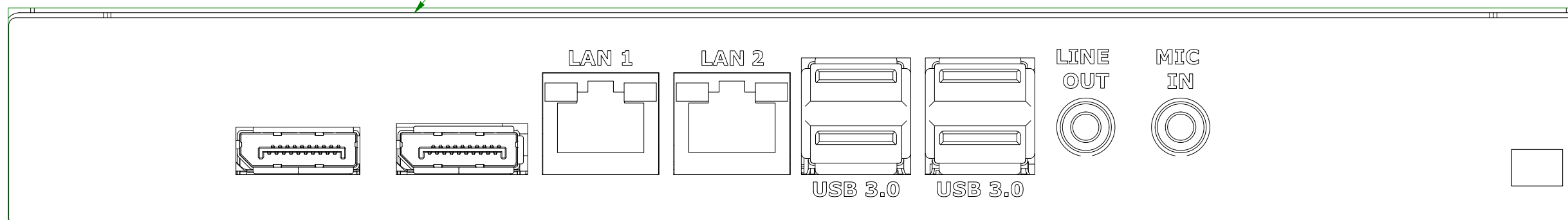
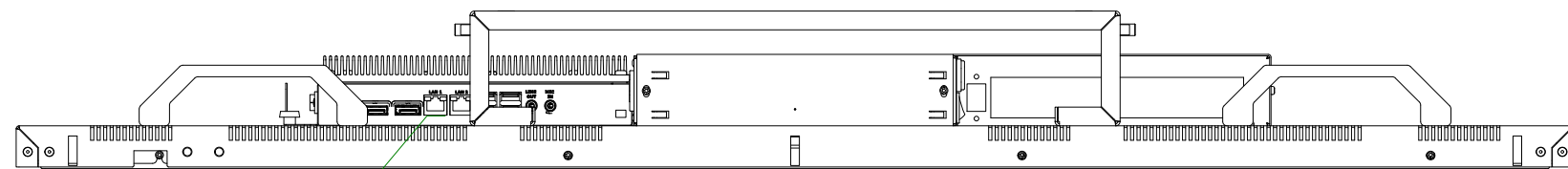

Ansteuerung Control	Bestellnummer Grundmodul ORDER NO. BASIC MODUL	de / EN	Datum DATE	Name NAME	Masseinheit: DIMENSION:	mm	Zeichnungsnummer: DRAWING NO:	POS46-R4.0
WebPoster M3	DS-92-024	Gezeichnet DESIGN	01.12.2016	Kulimaga	Option:	BEZEL	FRONTPLATE	TRUE-FLAT-GLASS
IQ Core-i5	DS-92-024	Kontrolliert CHECKED			Bestellnr.:			
IQ Atom	DS-91-933	Freigegeben APPROVED			ORDER NO.:			
Prisma Media ECO					Beschreibung / DESCRIPTION			
VideoPoster					POS-Line 46" connections IQ Core i5 / IQ Atom			
Prisma III A								
IoT								
R4	Touch entfernt		02.09.2024	sr				
R4	NEU:DS-92-024 i5 ALT:DS-91-528 Endat		04.09.2018	ek				
R4	IoT hinzu + Videoposter IV war III		19.07.2017	ce				
R4	Erstausgabe / 1ST ISSUE		01.12.2016	ek				
status STATUS	Anderungen CHANGES		Datum DATE	Name NAME	Projektionsmethode: 1ST ANGLE PROJECTION	Zul. Abw. GENERAL LIMITS DIN ISO 2768-cK	FORTEC INTEGRATED FORTEC Integrated GmbH Augsburg Str. 2b 82110 Germering Tel.: +49 (89) 894363-0	
							Blatt SHEET	von OF
							5	17
							A3	

Copying of this document and giving to others and the use or communication of the contents thereof are forbidden without express authority. Offenders are liable to the payment of damages. All rights are reserved in the event of the grant of a patent or registration of utility model or design.

Die Weitergabe sowie Vervielfältigung dieser Unterlagen und Mitteilung ihres Inhalts ist nicht gestattet, soweit nicht ausdrücklich zugestanden. Zuwiderhandlungen verpflichten zu Schadensersatz. Alle Rechte für den Fall der Patentverteilung oder GM-Eintragung vorbehalten.

Copying of this document and giving to others and the use or communication of the contents thereof are forbidden without express authority. Offenders are liable to the payment of damages. All rights are reserved in the event of the grant of a patent or registration of utility model or design.

Die Weitergabe sowie Vervielfältigung dieser Unterlagen und Mitteilung ihres Inhalts ist nicht gestattet, soweit nicht ausdrücklich zugestanden. Zuwiderhandlungen verpflichten zu Schadenersatz. Alle Rechte für den Fall der Patentverteilung oder GM-Eintragung vorbehalten.

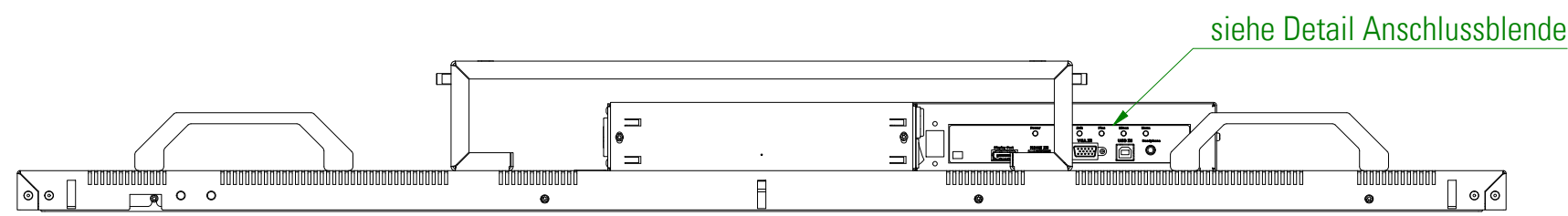

Prisma Media ECO

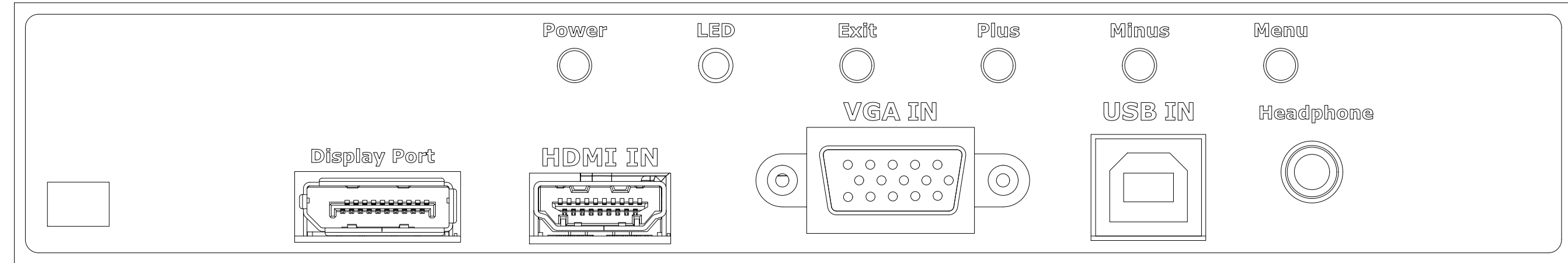

Prisma III A

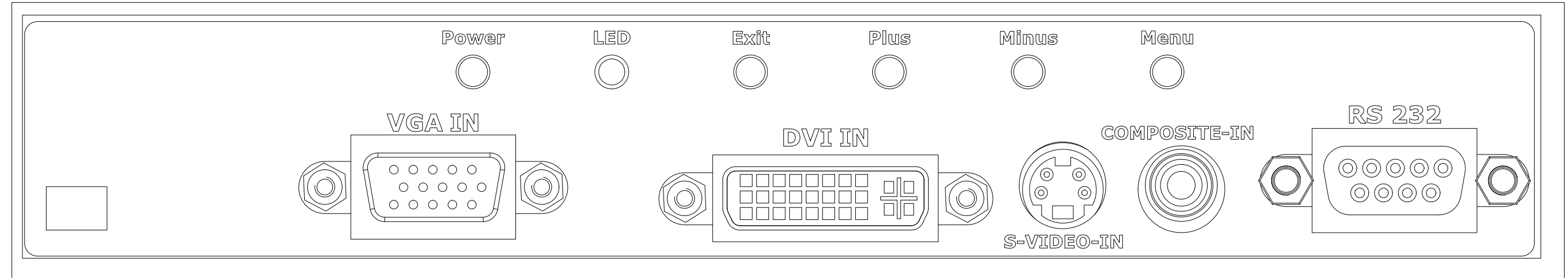

Ansteuerung Control	Bestellnummer Grundmodul ORDER NO. BASIC MODUL	de / EN	Datum DATE	Name NAME	Masseinheit: DIMENSION: mm	Zeichnungsnummer: DRAWING NO: POS46-R4.0
WebPoster M3		Gezeichnet DESIGN	01.12.2016	Kulimaga	Option: BEZEL	FRONTPLATE
IQ Core-i5		Kontrolliert CHECKED			Option: TRUE-FLAT-GLASS	
IQ Atom		Freigegeben APPROVED			Bestellnr.: ORDER NO.:	
Prisma Media ECO	DS-91-485				Beschreibung / DESCRIPTION	
VideoPoster					POS-Line 46"connections Prisma Media ECO/ Prisma IIIA	
Prisma III A	DS-91-487					
IoT						
R4	Touch entfernt		02.09.2024	sr		
R4	NEU:DS-92-024 i5 ALT:DS-91-528 Endat		04.09.2018	ek		
R4	IoT hinzu + Videoposter IV war III		19.07.2017	ce		
R4	Erstausgabe / 1ST ISSUE		01.12.2016	ek		
status STATUS	Anderungen CHANGES		Datum DATE	Name NAME	Projektionsmethode: 1ST ANGLE PROJECTION	Zul. Abw. GENERAL LIMITS DIN ISO 2768-cK
						FORTEC INTEGRATED
						Blatt SHEET 6 von OF 17
						FORTEC Integrated GmbH Augsburger Str. 2b 82110 Germering Tel.: +49 (89) 894363-0
						A3

Copying of this document and giving to others and the use or communication of the contents thereof are forbidden without express authority. Offenders are liable to the payment of damages. All rights are reserved in the event of the grant of a patent or registration of utility model or design.

Die Weitergabe sowie Vervielfältigung dieser Unterlagen und Mitteilung ihres Inhalts ist nicht gestattet, soweit nicht ausdrücklich zugestanden. Zuwiderhandlungen verpflichten zu Schadenersatz. Alle Rechte für den Fall der Patentverteilung oder GM-Eintragung vorbehalten

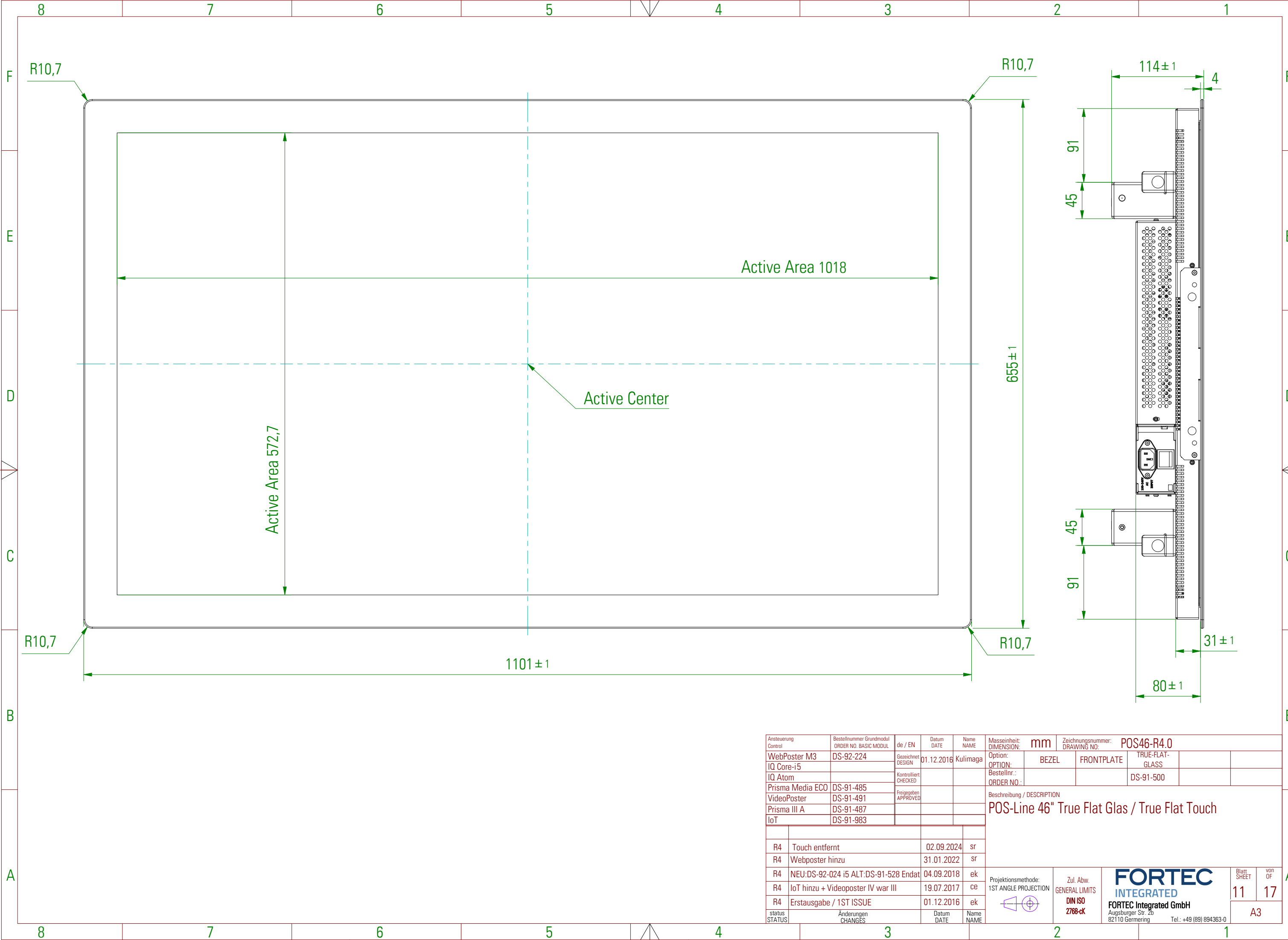

Ansteuerung Control	Bestellnummer Grundmodul ORDER NO. BASIC MODUL	de / EN	Datum DATE	Name NAME	Masseinheit: DIMENSION:	mm	Zeichnungsnummer: DRAWING NO:	POS46-R4.0			
WebPoster M3	DS-92-224	Gezeichnet DESIGN	01.12.2016	Kulimaga	Option:	BEZEL	FRONTPLATE	TRUE-FLAT-GLASS			
IQ Core-i5		Kontrolliert CHECKED			Bestellnr.:			DS-91-500			
IQ Atom		Freigegeben APPROVED			ORDER NO.:						
Prisma Media ECO	DS-91-485				Beschreibung / DESCRIPTION						
VideoPoster	DS-91-491				POS-Line 46" True Flat Glas / True Flat Touch						
Prisma III A	DS-91-487										
IoT	DS-91-983										
R4	Touch entfernt		02.09.2024	sr							
R4	Webposter hinzu		31.01.2022	sr							
R4	NEU:DS-92-024 i5 ALT:DS-91-528 Endat		04.09.2018	ek							
R4	IoT hinzu + Videoposter IV war III		19.07.2017	ce							
R4	Erstausgabe / 1ST ISSUE		01.12.2016	ek							
status STATUS	Anderungen CHANGES		Datum DATE	Name NAME	Projektionsmethode: 1ST ANGLE PROJECTION	Zul. Abw. GENERAL LIMITS DIN ISO 2768-cK		FORTEC INTEGRATED FORTEC Integrated GmbH Augsburg Str. 2b 82110 Germering Tel.: +49 (89) 894363-0		Blatt SHEET 11	von OF 17
										A3	

Copying of this document and giving to others and the use or communication of the contents thereof are forbidden without express authority. Offenders are liable to the payment of damages. All rights are reserved in the event of the grant of a patent or registration of utility model or design.

Die Weitergabe sowie Vervielfältigung dieser Unterlagen und Mitteilung ihres Inhalts ist nicht gestattet, soweit nicht ausdrücklich zugestanden. Zuwiderhandlungen verpflichten zu Schadenersatz. Alle Rechte für den Fall der Patentverteilung oder GM-Eintragung vorbehalten

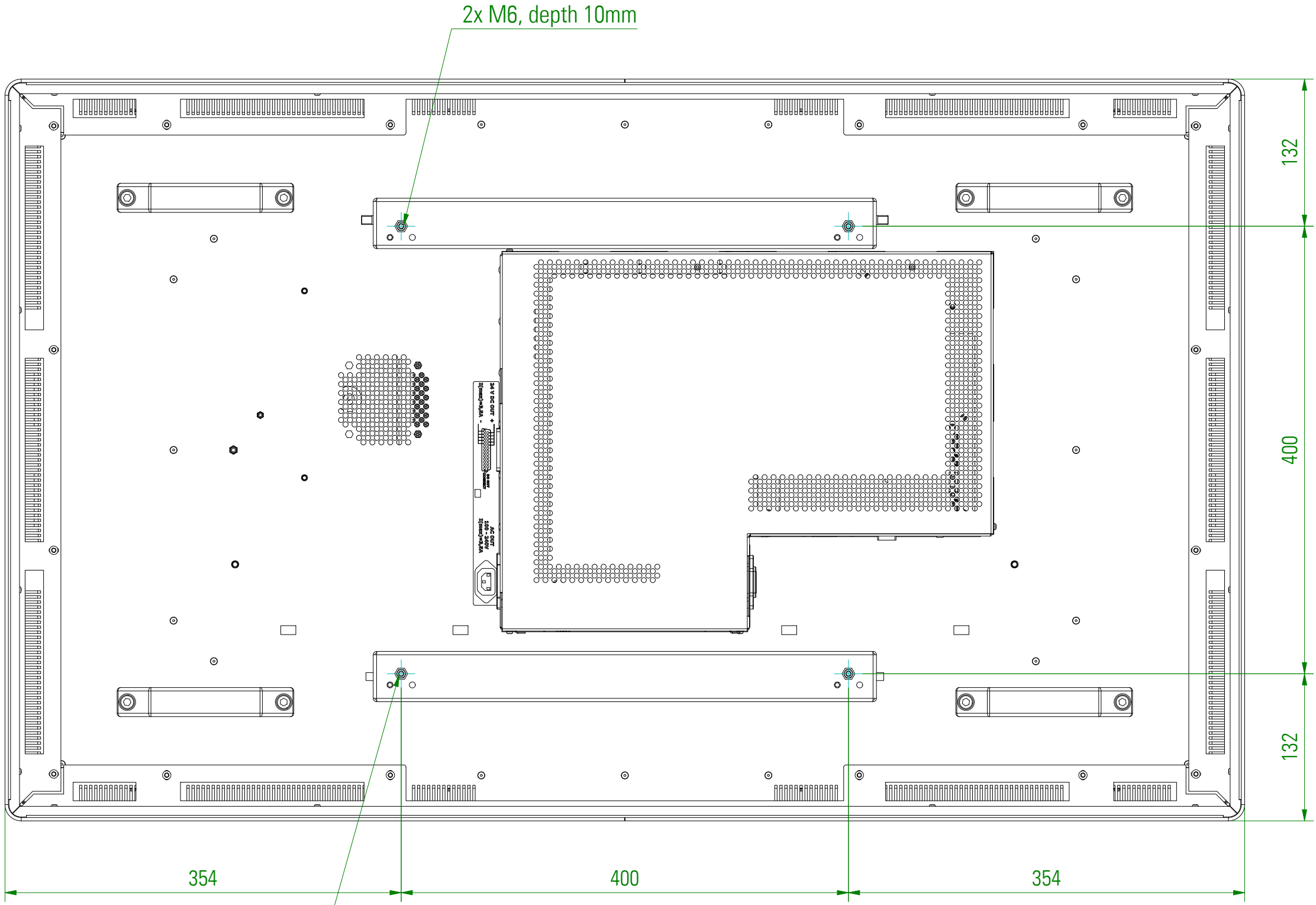

2x M6, depth 10mm

Ansteuerung Control	Bestellnummer Grundmodul ORDER NO. BASIC MODUL	de / EN	Datum DATE	Name NAME	Masseinheit: DIMENSION: mm	Zeichnungsnummer: DRAWING NO. POS46-R4.0			
WebPoster M3	DS-92-224	Gezeichnet DESIGN	01.12.2016	Kulimaga	Option: OPTION:	BEZEL	FRONTPLATE	TRUE-FLAT-GLASS	TRUE FLAT FRAME
IQ Core-i5		Kontrolliert CHECKED			Bestellnr.: ORDER NO.:				DS-91-703
Prisma Media ECO	DS-91-485	Freigegeben APPROVED			Beschreibung / DESCRIPTION				
VideoPoster	DS-91-491				POS-Line 46" True Flat Rahmen / True Flat Touch				
Prisma III A	DS-91-487								
IoT	DS-91-983								
R4	Touch entfernt		02.09.2024	sr					
R4	Webposter hinzu		31.01.2022	sr					
R4	NEU:DS-92-024 i5 ALT:DS-91-528 Endat		04.09.2018	ek					
R4	IoT hinzu + Videoposter IV war III		19.07.2017	ce					
R4	Erstausgabe / 1ST ISSUE		01.12.2016	ek					
status STATUS	Anderungen CHANGES		Datum DATE	Name NAME	Projektionsmethode: 1ST ANGLE PROJECTION	Zul. Abw. GENERAL LIMITS DIN ISO 2768-cK	FORTEC INTEGRATED FORTEC Integrated GmbH Augsburg Str. 2b 82110 Germering Tel.: +49 (89) 894363-0		Blatt SHEET 14 von OF 17
								A3	

Copying of this document and giving to others and the use or communication of the contents thereof are forbidden without express authority. Offenders are liable to the payment of damages. All rights are reserved in the event of the grant of a patent or registration of utility model or design.

Die Weitergabe sowie Vervielfältigung dieser Unterlagen und Mitteilung ihres Inhalts ist nicht gestattet, soweit nicht ausdrücklich zugestanden. Zuwiderhandlungen verpflichten zu Schadensersatz. Alle Rechte für den Fall der Patentverteilung oder GM-Eintragung vorbehalten

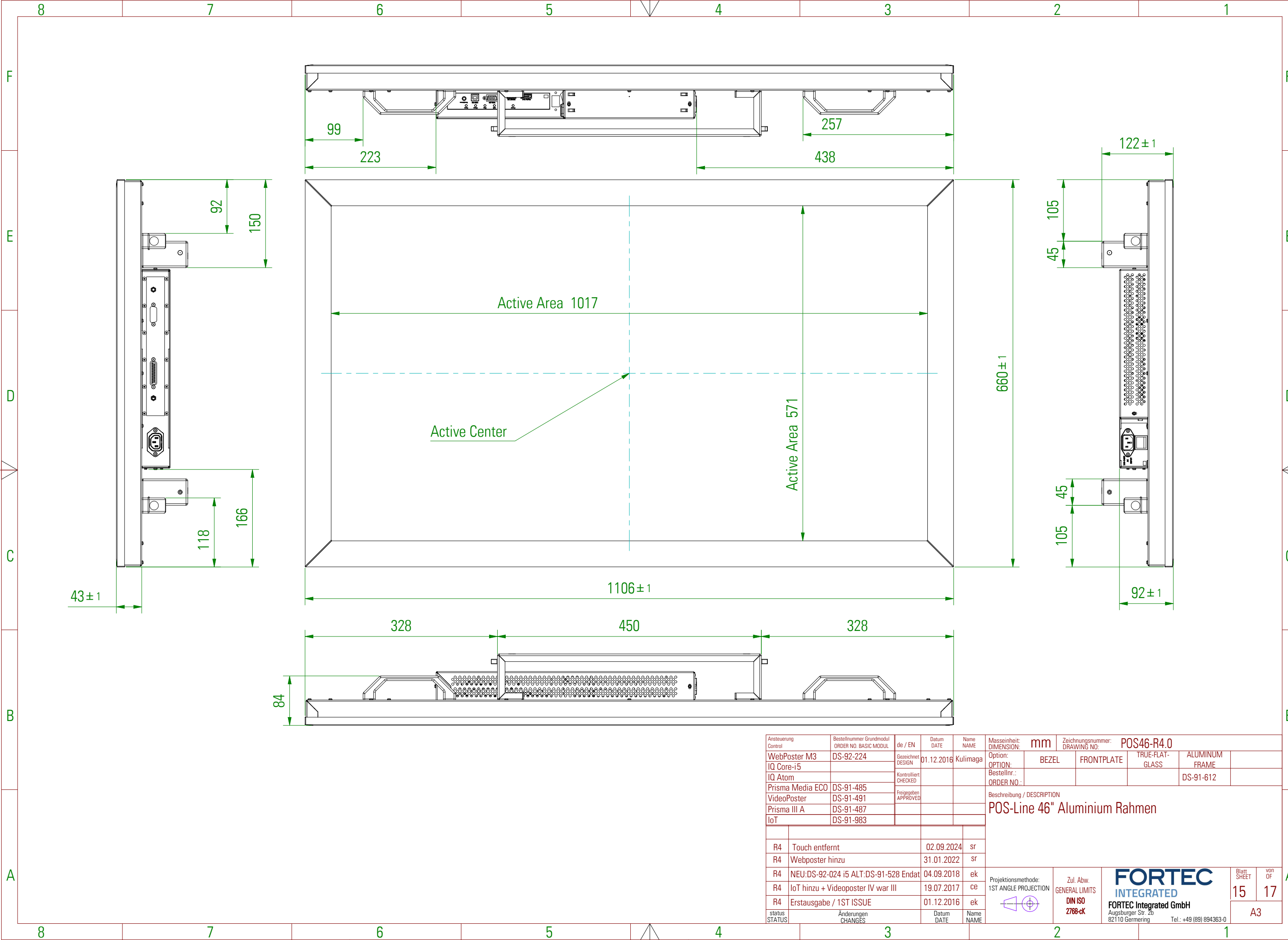

Ansteuerung Control	Bestellnummer Grundmodul ORDER NO. BASIC MODUL	de / EN	Datum DATE	Name NAME	Masseinheit: DIMENSION: mm	Zeichnungsnummer: DRAWING NO: POS46-R4.0			
WebPoster M3	DS-92-224	Gezeichnet DESIGN	01.12.2016	Kulimaga	Option: BEZEL	FRONTPLATE	TRUE-FLAT-GLASS	ALUMINUM FRAME	
IQ Core-i5		Kontrolliert CHECKED			Option: ORDER NO.:			DS-91-612	
IQ Atom		Freigegeben APPROVED			Beschreibung / DESCRIPTION				
Prisma Media ECO	DS-91-485				POS-Line 46" Aluminium Rahmen				
VideoPoster	DS-91-491								
Prisma III A	DS-91-487								
IoT	DS-91-983								
R4	Touch entfernt		02.09.2024	sr					
R4	Webposter hinzu		31.01.2022	sr					
R4	NEU:DS-92-024 i5 ALT:DS-91-528 Endat		04.09.2018	ek					
R4	IoT hinzu + Videoposter IV war III		19.07.2017	ce					
R4	Erstausgabe / 1ST ISSUE		01.12.2016	ek					
status STATUS	Änderungen CHANGES		Datum DATE	Name NAME	Projektionsmethode: 1ST ANGLE PROJECTION	Zul. Abw. GENERAL LIMITS DIN ISO 2768-cK	FORTEC INTEGRATED FORTEC Integrated GmbH Augsburg Str. 2b 82110 Germering Tel.: +49 (89) 894363-0		Blatt SHEET 15 von OF 17
							A3		

Copying of this document and giving to others and the use or communication of the contents thereof are forbidden without express authority. Offenders are liable to the payment of damages. All rights are reserved in the event of the grant of a patent or registration of utility model or design.

Die Weitergabe sowie Vervielfältigung dieser Unterlagen und Mitteilung ihres Inhalts ist nicht gestattet, soweit nicht ausdrücklich zugestanden. Zuwiderhandlungen verpflichten zu Schadenersatz. Alle Rechte für den Fall der Patentverteilung oder GM-Eintragung vorbehalten

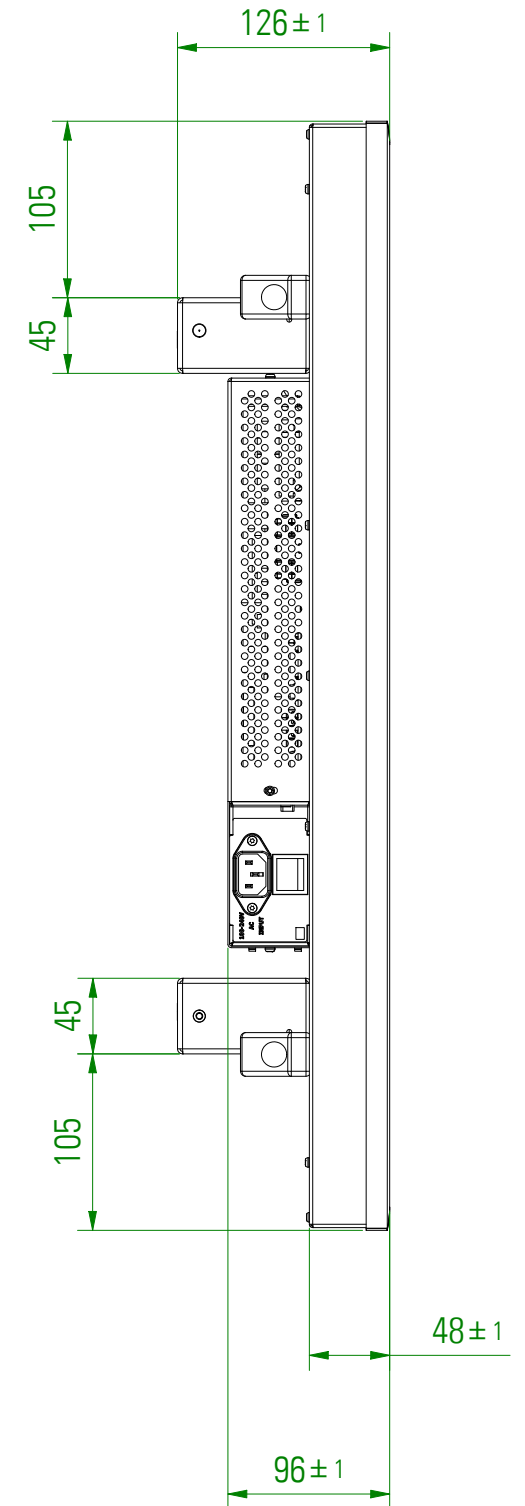
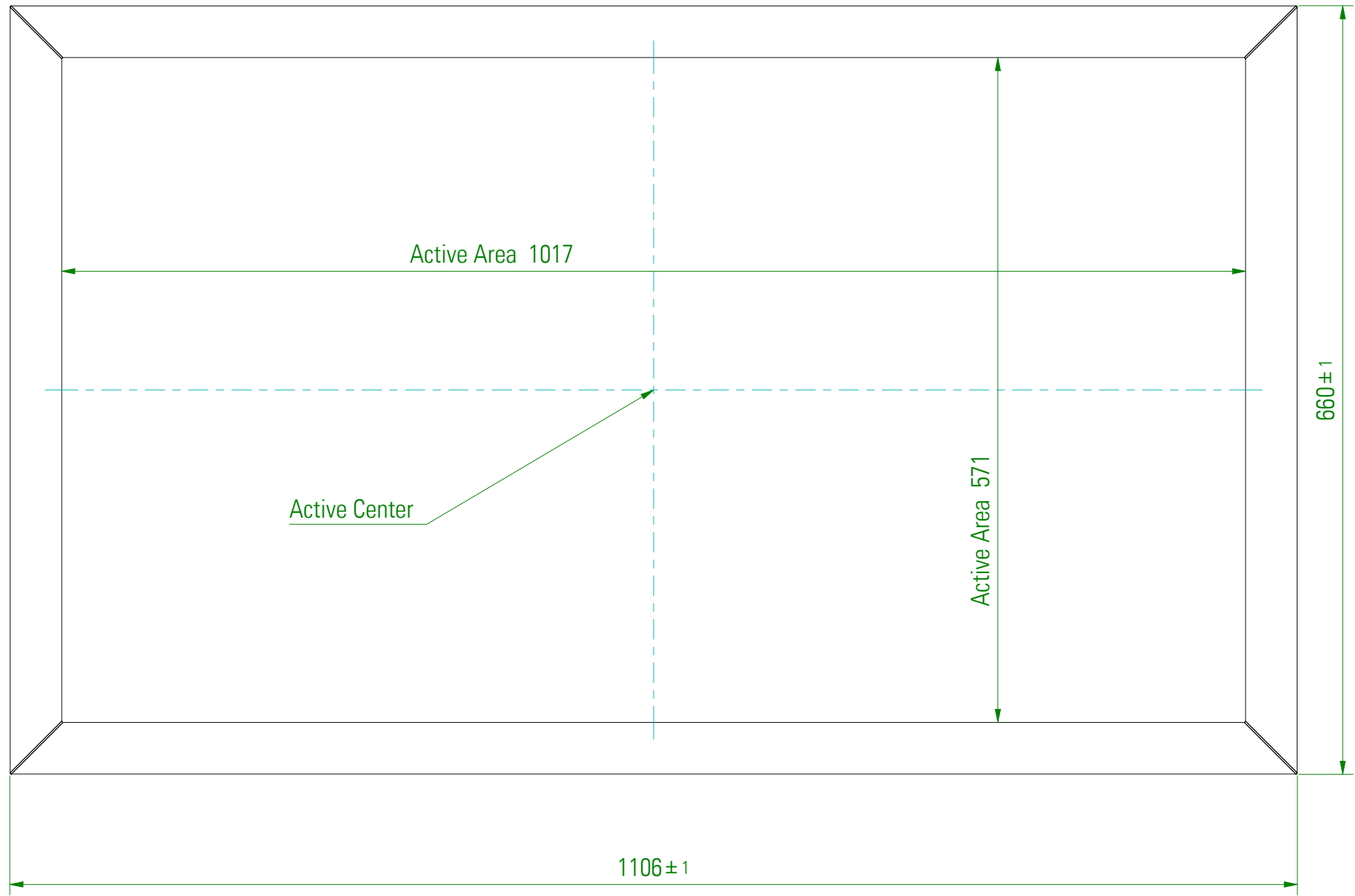

Ansteuerung Control	Bestellnummer Grundmodul ORDER NO. BASIC MODUL	de / EN	Datum DATE	Name NAME	Masseinheit: DIMENSION:	Zeichnungsnummer: DRAWING NO: POS46-R4.0				
WebPoster M3	DS-92-224	Gezeichnet DESIGN	01.12.2016	Kulimaga	Option:	BEZEL	FRONTPLATE	TRUE-FLAT-GLASS	ALUMINUM FRAME	SAFETY GLASS
IQ Core-i5		Kontrolliert CHECKED			Bestellnr.:				DS-91-612	DS-91-421
Prisma Media ECO	DS-91-485	Freigegeben APPROVED			ORDER NO.:					
VideoPoster	DS-91-491				Beschreibung / DESCRIPTION					
Prisma III A	DS-91-487				POS-Line 46" Aluminium Rahmen mit Sicherheitsglas					
IoT	DS-91-983									
R4	Touch entfernt		02.09.2024	sr						
R4	Webposter hinzu		31.01.2022	sr						
R4	NEU:DS-92-024 i5 ALT:DS-91-528 Endat		04.09.2017	ek						
R4	IoT hinzu + Videoposter lv war III		19.07.2017	ce						
R4	Erstausgabe / 1ST ISSUE		01.12.2016	ek						
status STATUS	Änderungen CHANGES		Datum DATE	Name NAME	Projektionsmethode: 1ST ANGLE PROJECTION	Zul. Abw. GENERAL LIMITS DIN ISO 2768-cK			Blatt SHEET	von OF
							FORTEC Integrated GmbH Augsburg Str. 2b 82110 Germering Tel.: +49 (89) 894363-0		16	17
									A3	

Copying of this document and giving to others and the use or communication of the contents thereof are forbidden without express authority. Offenders are liable to the payment of damages. All rights are reserved in the event of the grant of a patent or registration of utility model or design.

Die Weitergabe sowie Vervielfältigung dieser Unterlagen und Mitteilung ihres Inhalts ist nicht gestattet, soweit nicht ausdrücklich zugestanden. Zuwiderhandlungen verpflichten zu Schadenersatz. Alle Rechte für den Fall der Patentverteilung oder GM-Eintragung vorbehalten

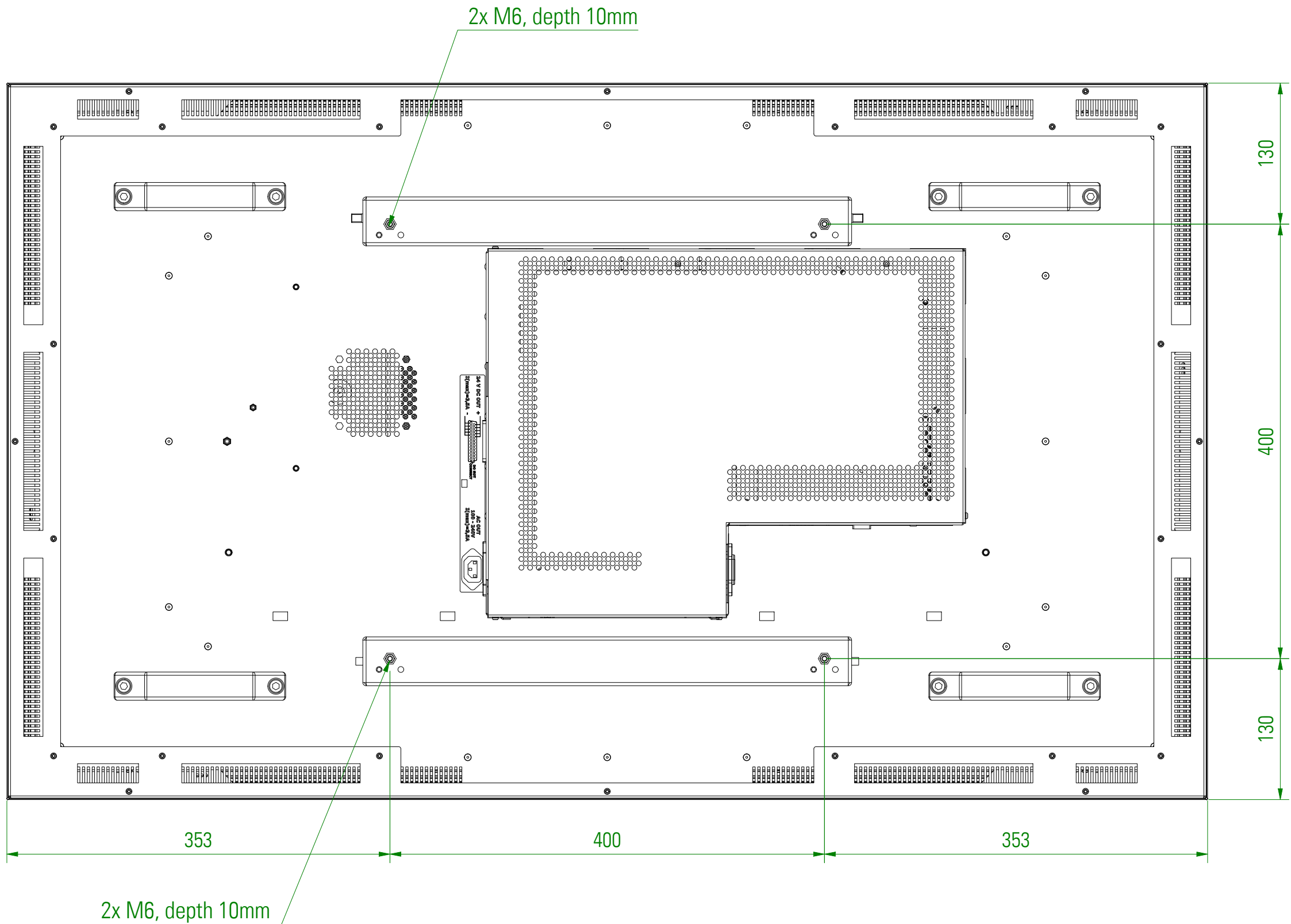

Ansteuerung Control	Bestellnummer Grundmodul ORDER NO. BASIC MODUL	de / EN	Datum DATE	Name NAME	Masseinheit: DIMENSION:	Zeichnungsnummer: DRAWING NO:	POS46-R4.0 TRUE-FLAT-GLASS ALUMINIUM FRAME SAFETY GLASS		
WebPoster M3	DS-92-224	Gezeichnet DESIGN	01.12.2016	Kulimaga	Option:	BEZEL	FRONTPLATE	DS-91-612	DS-91-420
IQ Core-i5		Kontrolliert CHECKED			Option:				
IQ Atom		Freigegeben APPROVED			ORDER NO.:				
Prisma Media ECO	DS-91-485				Beschreibung / DESCRIPTION				
VideoPoster	DS-91-491				POS-Line 46" Aluminium Rahmen / Aluminium Rahmen mit Sicherheitsglas				
Prisma III A	DS-91-487								
IoT	DS-91-983								
R4	Touch entfernt		02.09.2024	sr					
R4	Webposter hinzu		31.01.2022	sr					
R4	NEU:DS-92-024 i5 ALT:DS-91-528 Endat		04.09.2018	ek					
R4	IoT hinzu + Videoposter IV war III		19.07.2017	ce					
R4	Erstausgabe / 1ST ISSUE		01.12.2016	ek					
status STATUS	Änderungen CHANGES		Datum DATE	Name NAME	Projektionsmethode: 1ST ANGLE PROJECTION	Zul. Abw. GENERAL LIMITS DIN ISO 2768-cK	FORTEC INTEGRATED FORTEC Integrated GmbH Augsburg Str. 2b 82110 Germering Tel.: +49 (89) 894363-0		Blatt SHEET 17 von OF 17 A3